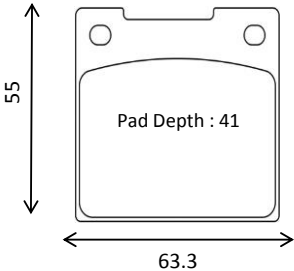
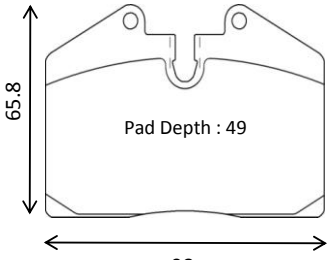
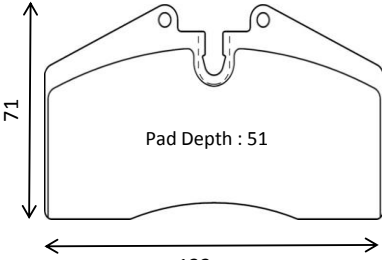
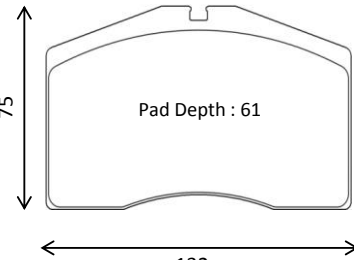
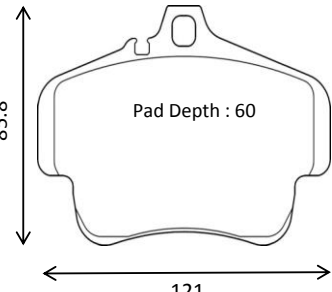
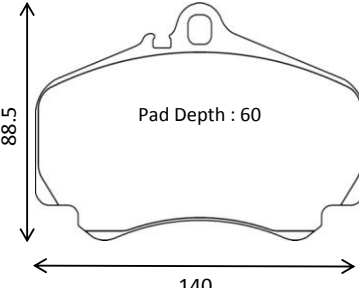
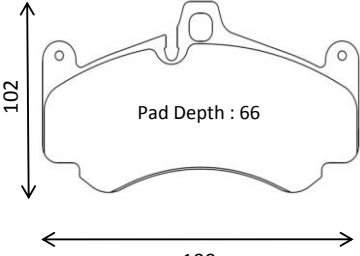
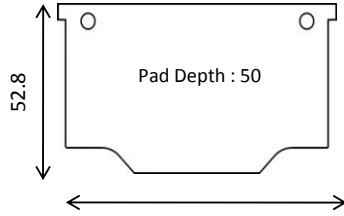
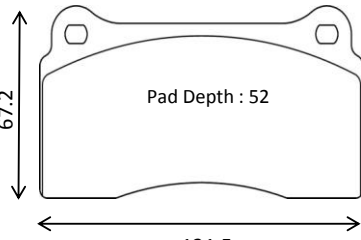
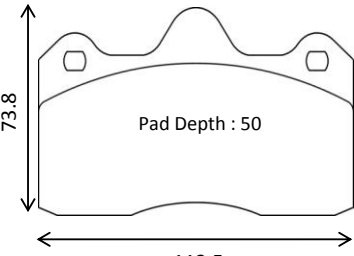
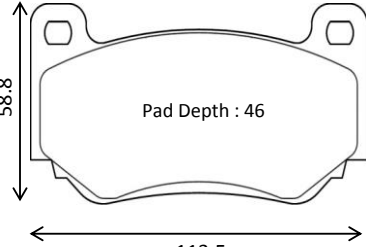
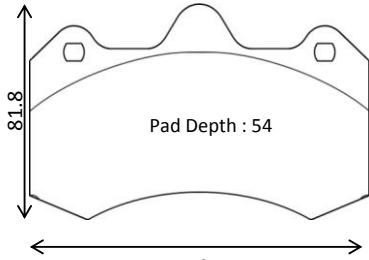
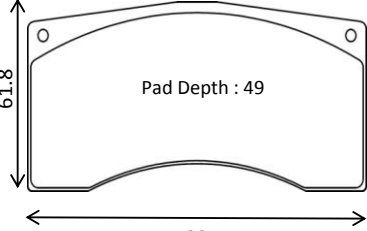
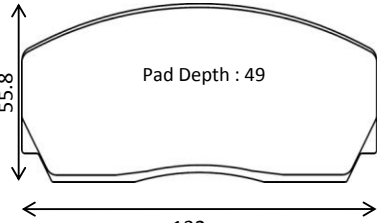
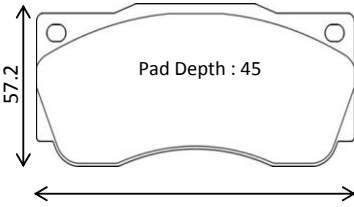
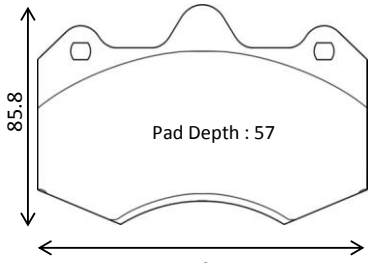
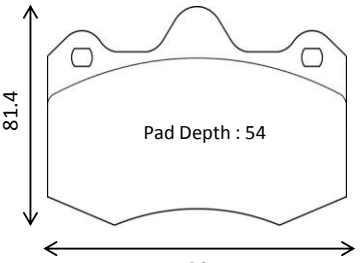
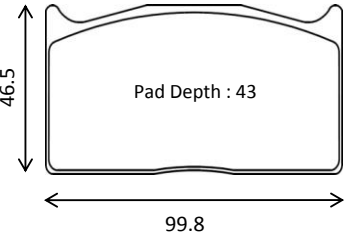
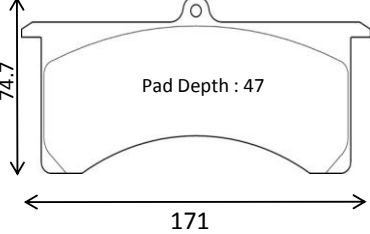
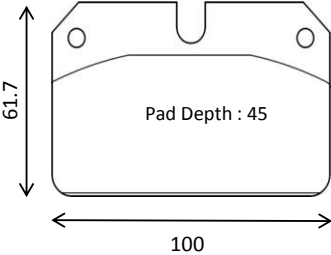
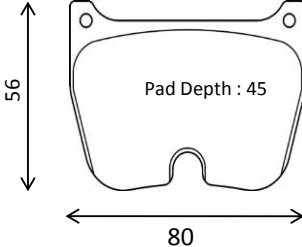
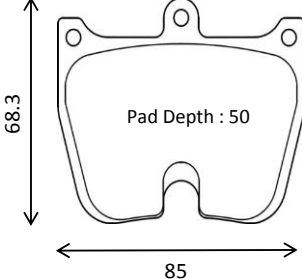
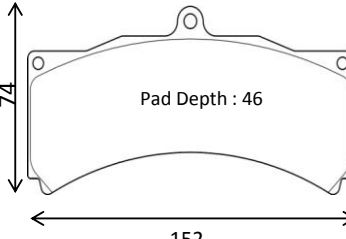
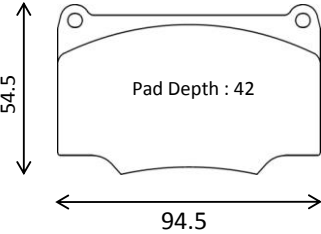
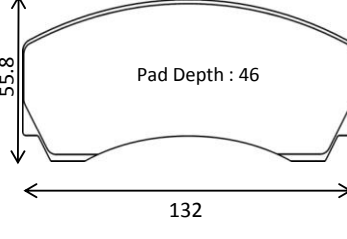
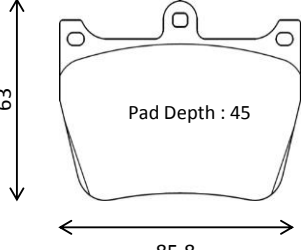
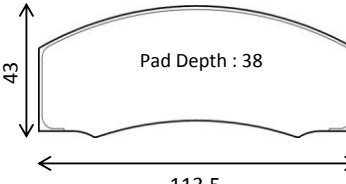
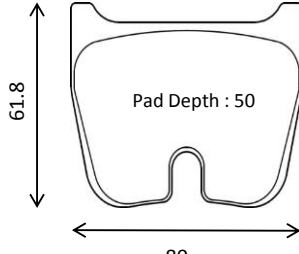
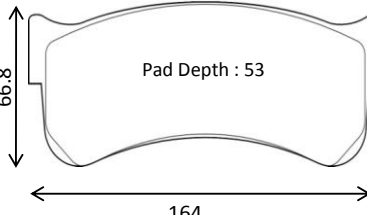
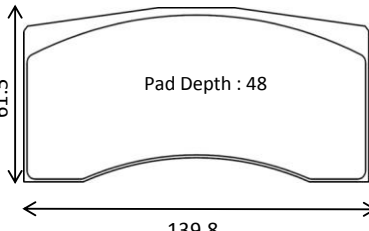
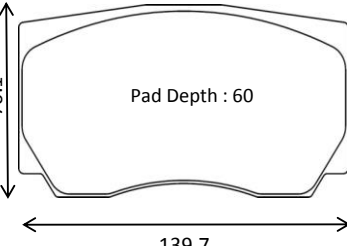
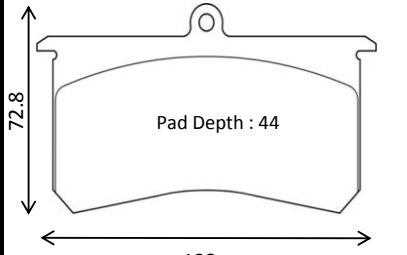
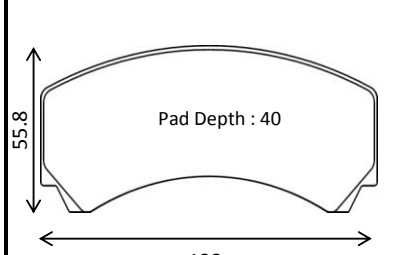
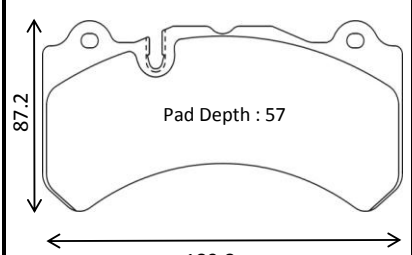
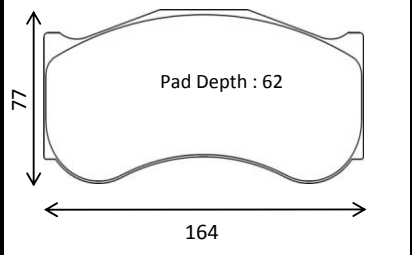
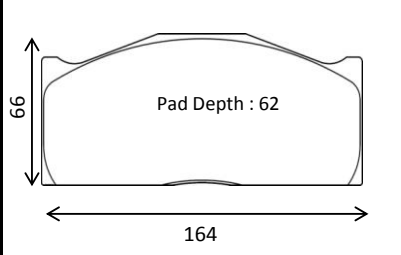
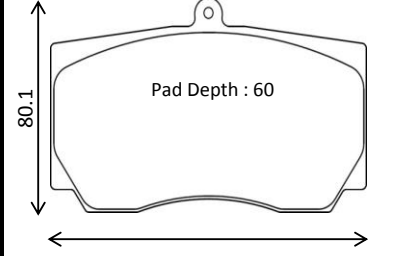
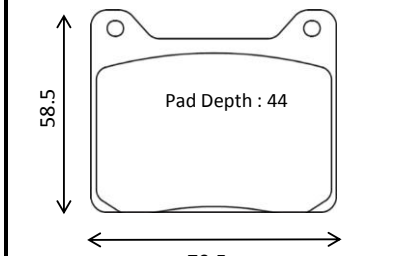
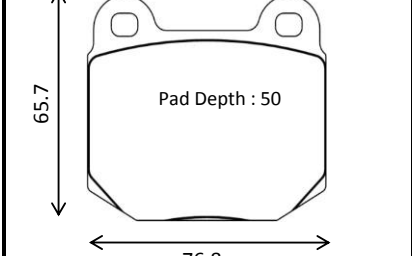
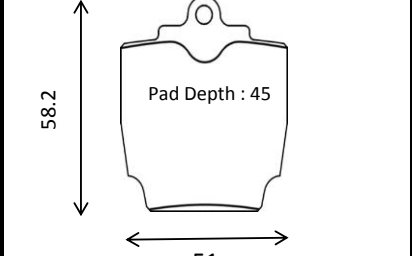
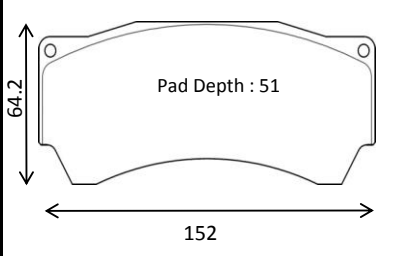
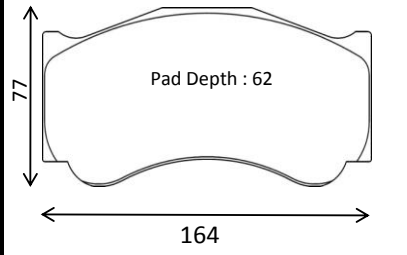
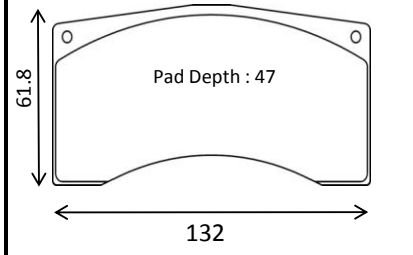
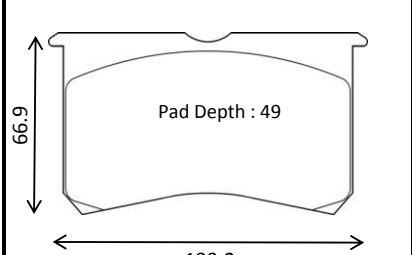
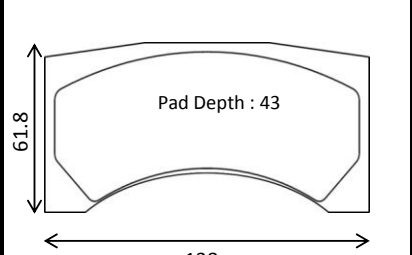
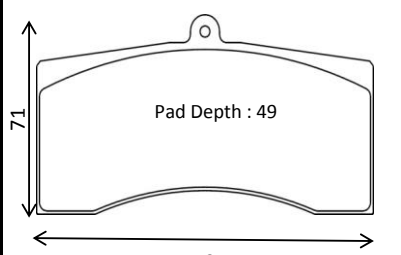
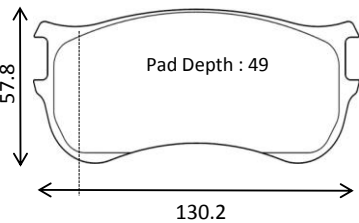
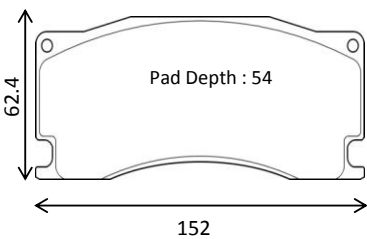
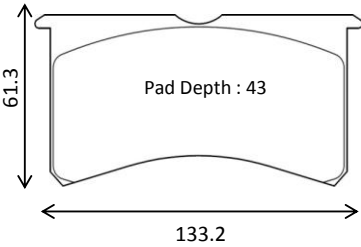
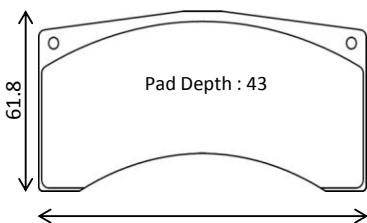
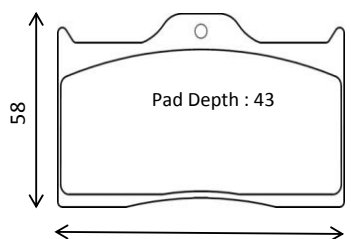
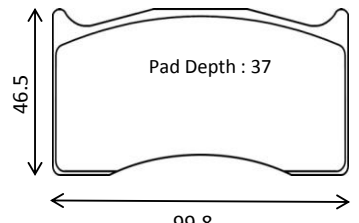
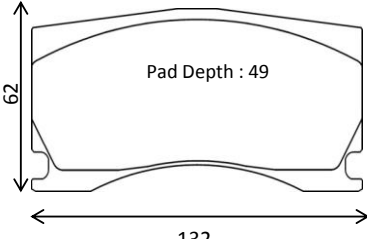
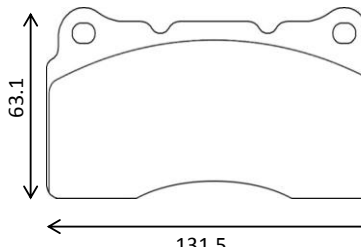
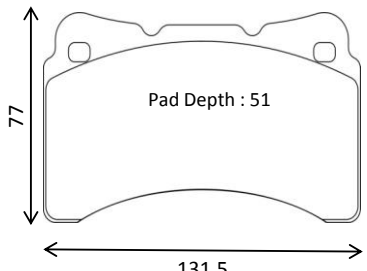
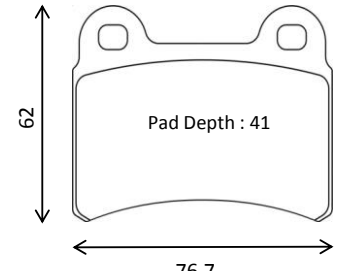
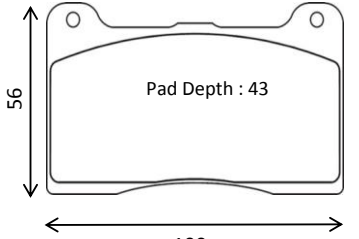
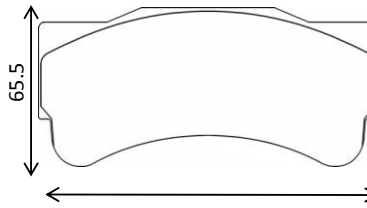
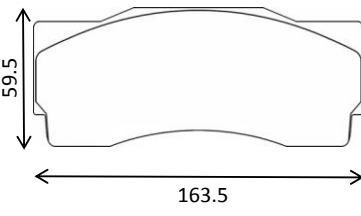
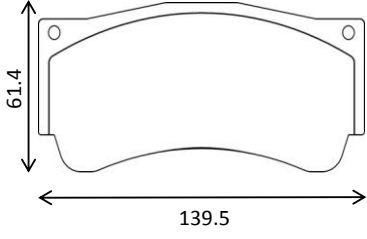
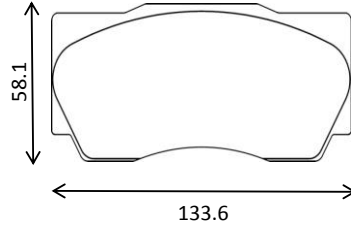

WMP331	WMP718	WMP719	WMP720	WMP757
 <p>55 63.3 Pad Depth : 41</p> <p>thickness : 14.0</p>	 <p>65.8 98 Pad Depth : 49</p> <p>thickness : 16.0 or 18.0</p>	 <p>71 132 Pad Depth : 51</p> <p>thickness : 18.0</p>	 <p>75 132 Pad Depth : 61</p> <p>thickness : 17.5 or 25.0</p>	 <p>85.8 121 Pad Depth : 60</p> <p>thickness : 16.5</p>
WMP780	WMP781	WMP798	WMP800	WMP808
 <p>88.5 140 Pad Depth : 60</p> <p>thickness : 16.5</p>	 <p>102 190 Pad Depth : 66</p> <p>thickness : 17.5 or 19.0</p>	 <p>52.8 100 Pad Depth : 50</p> <p>thickness : 16.0</p>	 <p>67.2 131.5 Pad Depth : 52</p> <p>thickness : 16.0 or 18.0</p>	 <p>73.8 113.5 Pad Depth : 50</p> <p>thickness : 16.5</p>
WMP809	WMP811	WMP813	WMP814	WMP815
 <p>58.8 113.5 Pad Depth : 46</p> <p>thickness : 14.0 or 16.0</p>	 <p>81.8 149 Pad Depth : 54</p> <p>thickness : 16.5</p>	 <p>61.8 132 Pad Depth : 49</p> <p>thickness : 14.0 or 16.0 or 18.0 or 20.0 or 25.0</p>	 <p>55.8 132 Pad Depth : 49</p> <p>thickness : 16.5 or 20.0</p>	<p>ENDLESS-RCP066</p>  <p>57.2 133.6 Pad Depth : 45</p> <p>thickness : 15.5</p>

WMP816	WMP817	WMP818	WMP819	WMP822
<p>ENDLESS-RCP080</p>  <p>thickness : 20.0</p>	 <p>thickness : 16.5</p>	 <p>thickness : 16.5</p>	 <p>thickness : 17.0, 18.0, 20.0, 25.0 or 28.0</p>	 <p>thickness : 16.0</p>
WMP829	WMP830	WMP831	WMP866	WMP876
 <p>thickness : 17.0 or 18.0 or 25.0</p>	<p>AP RACING</p>  <p>thickness : 20.0</p>	 <p>thickness : 12.5</p>	<p>ENDLESS-RCP085</p>  <p>thickness : 13.5</p>	 <p>thickness : 25.0 or 28.0 or 30.0</p>
WMP888	WMP891	WMP892	WMP893	WMP894
 <p>thickness : 16.8</p>	 <p>thickness : 15.0</p>	 <p>thickness : 16.0</p>	 <p>thickness : 15.0</p>	 <p>thickness : 16.0 or 20.0</p>

WMP895	WMP896	WMP897	WMP898	WMP899
 <p>46.5 99.8 Pad Depth : 43</p> <p>thickness : 16.0 or 20.0</p>	 <p>74.7 171 Pad Depth : 47</p> <p>thickness : 16.5 or 20</p>	 <p>61.7 100 Pad Depth : 45</p> <p>thickness : 12.5</p>	 <p>56 80 Pad Depth : 45</p> <p>thickness : 18.0 or 20.0</p>	 <p>68.3 85 Pad Depth : 50</p> <p>thickness : 18.0 or 20.0 or 22.0</p>
WMP1091	WMP1092	WMP1093	WMP1094	WMP1095
 <p>74 152 Pad Depth : 46</p> <p>thickness : 18.0 or 20.0 or 25.0</p>	 <p>54.5 94.5 Pad Depth : 42</p> <p>thickness : 16.0</p>	<p>Integrated with the WMP1337</p>	 <p>55.8 132 Pad Depth : 46</p> <p>thickness : 16.5</p>	 <p>63 85.8 Pad Depth : 45</p> <p>thickness : 15.0 or 18.0</p>
WMP1096	WMP1097	WMP1098	WMP1099	WMP1135
 <p>43 113.5 Pad Depth : 38</p> <p>thickness : 16.0</p>	 <p>61.8 80 Pad Depth : 50</p> <p>thickness : 18.0 or 20.0</p>	 <p>66.8 164 Pad Depth : 53</p> <p>thickness : 25.0 or 29.0</p>	 <p>61.5 139.8 Pad Depth : 48</p> <p>thickness : 16.0 or 18.0 or 20.0 or 26.0 or 28.0</p>	 <p>70.1 139.7 Pad Depth : 60</p> <p>thickness : 18.0 or 20.0 or 30.0</p>

WMP1136	WMP1150	WMP1295	WMP1306	WMP1307
 <p>Pad Depth : 44</p> <p>72.8</p> <p>133</p> <p>thickness : 20.0</p>	 <p>Pad Depth : 40</p> <p>55.8</p> <p>132</p> <p>thickness : 16.5 or 20.0</p>	 <p>Pad Depth : 57</p> <p>87.2</p> <p>189.8</p> <p>thickness : 16.8</p>	 <p>Pad Depth : 62</p> <p>77</p> <p>164</p> <p>thickness : 30.0</p>	 <p>Pad Depth : 62</p> <p>66</p> <p>164</p> <p>thickness : 28.0 or 30.0 or 32.0</p>
WMP1308	WMP1309	WMP1315	WMP1316	WMP1317
 <p>Pad Depth : 60</p> <p>80.1</p> <p>139.7</p> <p>thickness : 28.0 or 30.0</p>	 <p>Pad Depth : 44</p> <p>58.5</p> <p>79.5</p> <p>thickness : 12.5 or 14.0</p>	 <p>Pad Depth : 50</p> <p>65.7</p> <p>76.8</p> <p>thickness : 14.5</p>	 <p>Pad Depth : 45</p> <p>58.2</p> <p>51</p> <p>thickness : 18.0</p>	 <p>Pad Depth : 51</p> <p>64.2</p> <p>152</p> <p>thickness : 16.0</p>
WMP1318	WMP1319	WMP1320	WMP1321	WMP1322
 <p>Pad Depth : 62</p> <p>77</p> <p>164</p> <p>thickness : 30.0</p>	 <p>Pad Depth : 47</p> <p>61.8</p> <p>132</p> <p>thickness : 20.0</p>	<p>AP RACING</p>  <p>Pad Depth : 49</p> <p>66.9</p> <p>133.2</p> <p>thickness : 20.0</p>	 <p>Pad Depth : 43</p> <p>61.8</p> <p>138</p> <p>thickness : 17.5</p>	 <p>Pad Depth : 49</p> <p>71</p> <p>140</p> <p>thickness : 17.0 or 20.0 or 25.0 or 28.0</p>

WMP1328	WMP1332	WMP1335	WMP1337	WMP1345
 <p>Pad Depth : 49</p> <p>57.8</p> <p>130.2</p> <p>thickness : 28.5</p>	 <p>Pad Depth : 54</p> <p>62.4</p> <p>152</p> <p>thickness : 17.0</p>	<p>Willwood</p>  <p>Pad Depth : 43</p> <p>61.3</p> <p>133.2</p> <p>thickness : 16.5 or 20.0</p>	 <p>Pad Depth : 43</p> <p>61.8</p> <p>132</p> <p>thickness : 16.0 or 18.0</p>	 <p>Pad Depth : 43</p> <p>58</p> <p>100</p> <p>thickness : 12.5</p>
WMP1346	WMP1347	WMP1355	WMP1356	WMP1357
 <p>Pad Depth : 37</p> <p>46.5</p> <p>99.8</p> <p>thickness : 16.0 or 20.0 or 22.0</p>	 <p>Pad Depth : 49</p> <p>62</p> <p>132</p> <p>thickness : 16.0</p>	 <p>Pad Depth : 43</p> <p>63.1</p> <p>131.5</p> <p>thickness :</p>	 <p>Pad Depth : 51</p> <p>77</p> <p>131.5</p> <p>thickness : 15.0</p>	 <p>Pad Depth : 41</p> <p>62</p> <p>76.7</p> <p>thickness : 15.0</p>
WMP1363	WMP1367	WMP1368	WMP1369	WMP1370
 <p>Pad Depth : 43</p> <p>56</p> <p>100</p> <p>thickness : 12.5</p>	<p>ENDLESS-RCP121</p>  <p>Pad Depth : 43</p> <p>65.5</p> <p>163.5</p> <p>thickness : 25.0</p>	<p>ENDLESS-RCP122</p>  <p>Pad Depth : 43</p> <p>59.5</p> <p>163.5</p> <p>thickness : 25.0</p>	<p>ENDLESS-RCP146</p>  <p>Pad Depth : 43</p> <p>61.4</p> <p>139.5</p> <p>thickness : 18.0</p>	<p>ENDLESS-RCP151</p>  <p>Pad Depth : 43</p> <p>58.1</p> <p>133.6</p> <p>thickness : 15.0</p>

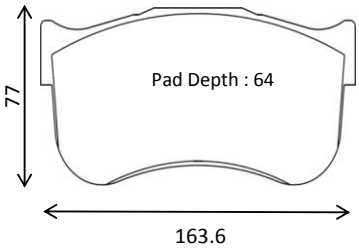
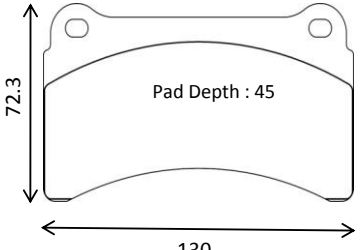
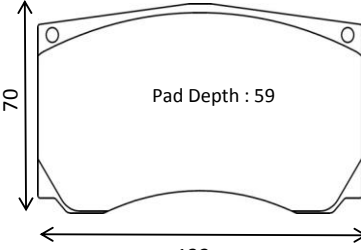
WMP1371	WMP1372	WMP1373		
 <p>Pad Depth : 64</p> <p>163.6</p> <p>77</p> <p>thickness : 25.0 or 30.0</p>	 <p>Pad Depth : 45</p> <p>130</p> <p>72.3</p> <p>thickness : 18.5</p>	 <p>Pad Depth : 59</p> <p>132</p> <p>70</p> <p>thickness : 16.0 or 20.0</p>		